

RAY ALLEN

PROFESSIONAL K-9 EQUIPMENT



INSTALLATION & OPERATION MANUAL

System Serial No. _____

Table of Contents

1) System Features.....	3
1.1) Heat Alert.....	3
2) System Components.....	4
2.1) Heads Up Display.....	4
2.2) Control POD.....	5
2.3) Remote / Pager.....	6
3) Starting the System.....	7
4) System Menu.....	7
5) System Message Descriptions.....	10
6) Product Care and Service.....	11
6.1) Heads Up Display.....	11
6.2) Remote / Pager.....	11
7) Troubleshooting.....	12
8) Installation.....	13
8.1) Read This First!.....	13
8.2) Before installation.....	13
8.3) Installation Kit Parts List.....	14
8.4) Charge the Remote/Pager.....	16
8.5) Placement of the Control POD.....	16
8.6) Electrical Specifications.....	17
8.7) Wire Harness Details.....	17
8.8) Window Lowering Feature Installation.....	20
8.9) Antenna Attachment.....	21
8.10) Temperature Sensor Placement.....	22
8.11) Lights and Horn Connection.....	22
8.12) MD10 F Ray Allen Fan Connection.....	22
8.13) Placement of Heads Up Display (HUD).....	23
8.14) Completing the Installation.....	24
8.15) Testing the HEAT ALERT™ System.....	25
8.16) Confirming Normal Operation.....	26
9) Warranty.....	27
10) Disclaimer.....	28

1) System Features

1.1) Heat Alert

The heat alert system monitors temperature, vehicle power, and motion inside the kennel (optional) to determine if the K9 is in danger of overheating.

Alert Delay: The alert delay postpones the heat alert function after system start-up or an alert reset. The duration of the delay is adjustable in the Heat Alert menu.

Voltage Monitor: The voltage that is fed to the system is monitored for low voltage conditions. If the voltage drops below about 8 volts, a Vehicle Power Alert will be triggered.

AUX Input: The system is equipped with an auxiliary input. An Aux Input Alert is triggered when this input is activated.

AUX Output: The auxiliary output can be connected some other alarm device such as a strobe, siren, GSM dialer, etc. When an alert is triggered, this output will become active. The type of active signal can be programmed to fit the application.

AUX Power: The auxiliary power output can supply vehicle power to a peripheral device. This output is only active when the F-Series system is powered on.

Temp Sensors: The system utilizes two digital temperature sensors for high accuracy as well as decreased false alarms. Both the of temp sensors must be at or over the Alert Temp set in the Heat Alert menu to trigger an alert.

Window Drop: The windows that are selected in the Heat Alert menu will roll down one at a time when a heat alert is triggered. The menu option can be set to roll down just the left, just the right, or both windows.

Fan Control: The optional fan is controlled both manually and automatically. The manual fan control is through the right button of the HUD and can be set to three different speeds or turned off. When a heat alert is triggered, the system will automatically turn the fan on at full speed.

Horn and Lights Alarm: There are dedicated outputs for the vehicle's lights and horn. These outputs begin to function after a programmable delay which begins when a heat alert is activated.

Motion Sensor: The motion sensor is an optional feature that will detect motion inside the kennel for a specified amount of time after the system has been turned off. For example, if the Heat Alert system is powered down, but the K9 is accidentally left in the vehicle, the system will detect the motion of the K9 and enter an alert state.

2) System Components

2.1) Heads Up Display

The Heads Up Display (HUD) is the primary user interface used to monitor real-time temperature measurements and system status, manually control the kennel's fan (if installed), and adjust system settings. When an alert condition exists, the HUD will display the alert message and can be used to reset the alert. The HUD is equipped with a back-light for the display. It is controlled by the left button and can be set to one of three brightness levels or turned off. When the system is powered up, the back-light will return to the brightness level it was set at when it was last turned off.

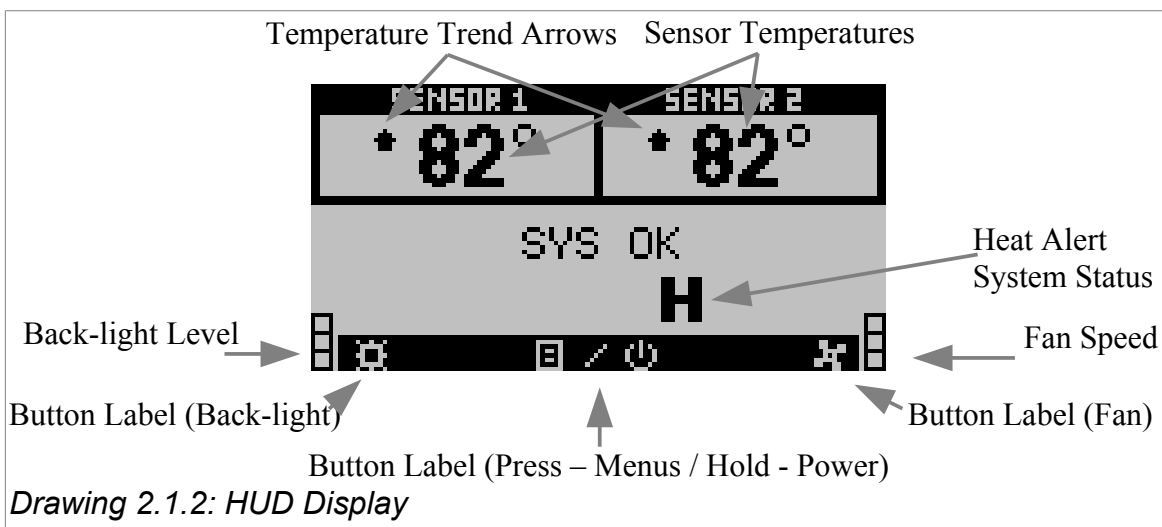
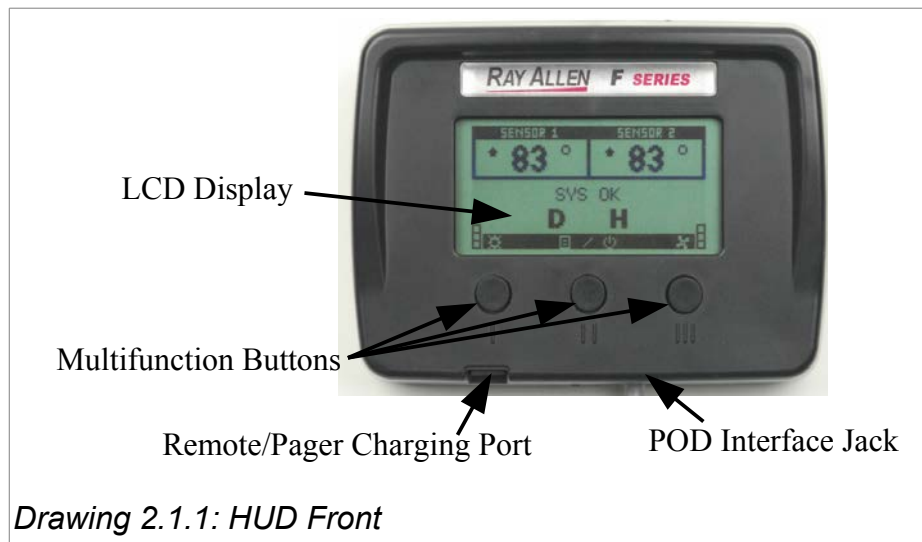

2.2) Control POD

The Control POD is the main power switching and logic control device. The system settings are saved in non-volatile memory on the POD. This means that even if power is disconnected from the system, the settings are saved and don't need to be reset.

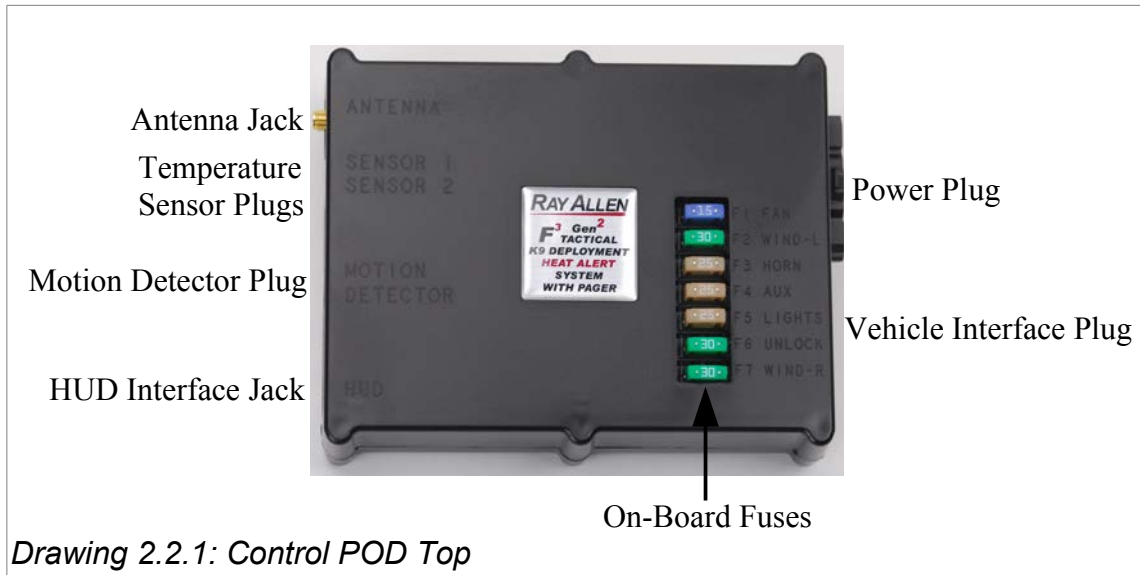

Reference	Function	Value (A)
F1	Fan	15A
F2	Window - Left	20A
F3	Horn	20A
F4	Aux	20A
F5	Lights	20A
F6	Not Used	15A
F7	Window - Right	20A

Table 2.2.1: On-Board Fuse Values

2.3) Remote / Pager

The Remote/Pager (RP) is the portable interface to the system. It displays almost exactly the same information as the HUD. The RP will notify of an alert condition by vibrating and beeping (unless muted in which case it will only vibrate) and can be used to reset the alert. After approximately one minute of no buttons being pressed, the display will turn off to conserve battery power, but the RP will continue to receive updates. The RP is equipped with a back-light for the display which can be turned on by pressing the right button. The RP is powered by a lithium-polymer rechargeable battery. It can be recharged using either the included 120V wall charger or the included charging pigtail which allows the RP to be recharged from the HUD. It could take more than an hour to fully recharge the battery but can be left on the charger indefinitely without causing damage. This type of battery also does not have a “memory” effect and so there is no need to fully discharge the battery before recharging.

Note: The Remote / Pager holster is constructed of a special polymer that can be cut to accommodate larger fingers to access the DEPLOY K-9 Button through the holster.

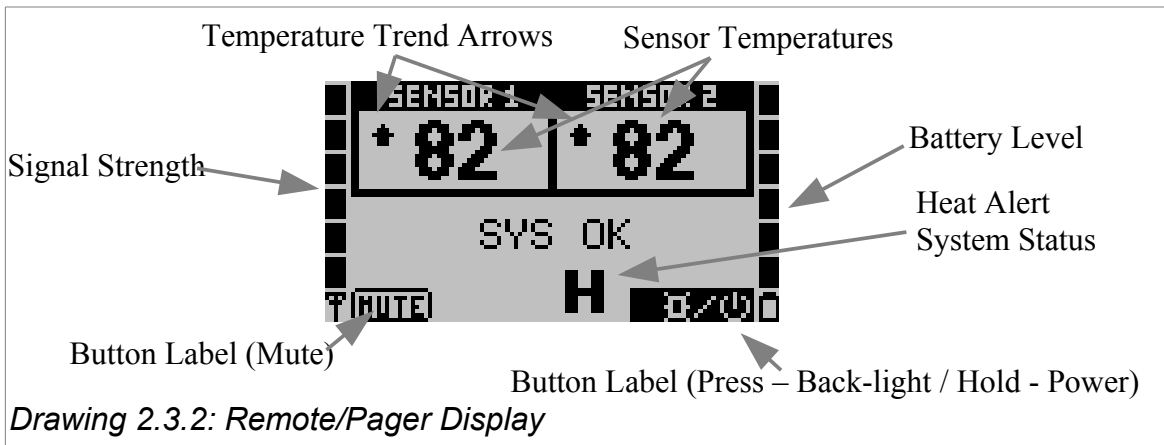
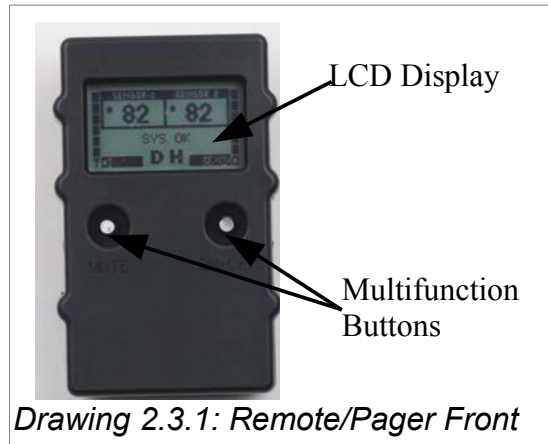

3) Starting the System

To power-up the system, hold down the center button located on the Heads Up Display (HUD). Release the button when the LCD changes. The system will perform a quick diagnostic. The display will show two independent temperature readings, and system status indicators. Along the bottom are controls for the back-light, fan (left and right button respectively), and menu access / power button.

Note: Your system is powered by direct connection to the vehicle battery and will remain on and functioning even when the vehicle is turned off. Therefore when your vehicle is not in service and/or you no longer require this system to function, you must manually turn the system OFF (press and hold the center button of the HUD).

4) System Menu

Access the particular system you wish to program by first pressing the center button on the HUD once. This brings you to the first level of your Setup menu.

To access the feature sub-menus, select the desired feature with the left and right buttons and then press the center button to enter that sub-menu.

To change a feature option, select the desired option with the left and right buttons and then press the center button to edit that option. The left and right buttons can then be used to change the option value. Once the option has been set to the desired value, pressing the center button will allow another option to be selected for editing.

Holding the center button will exit out of the current sub-menu or menu.

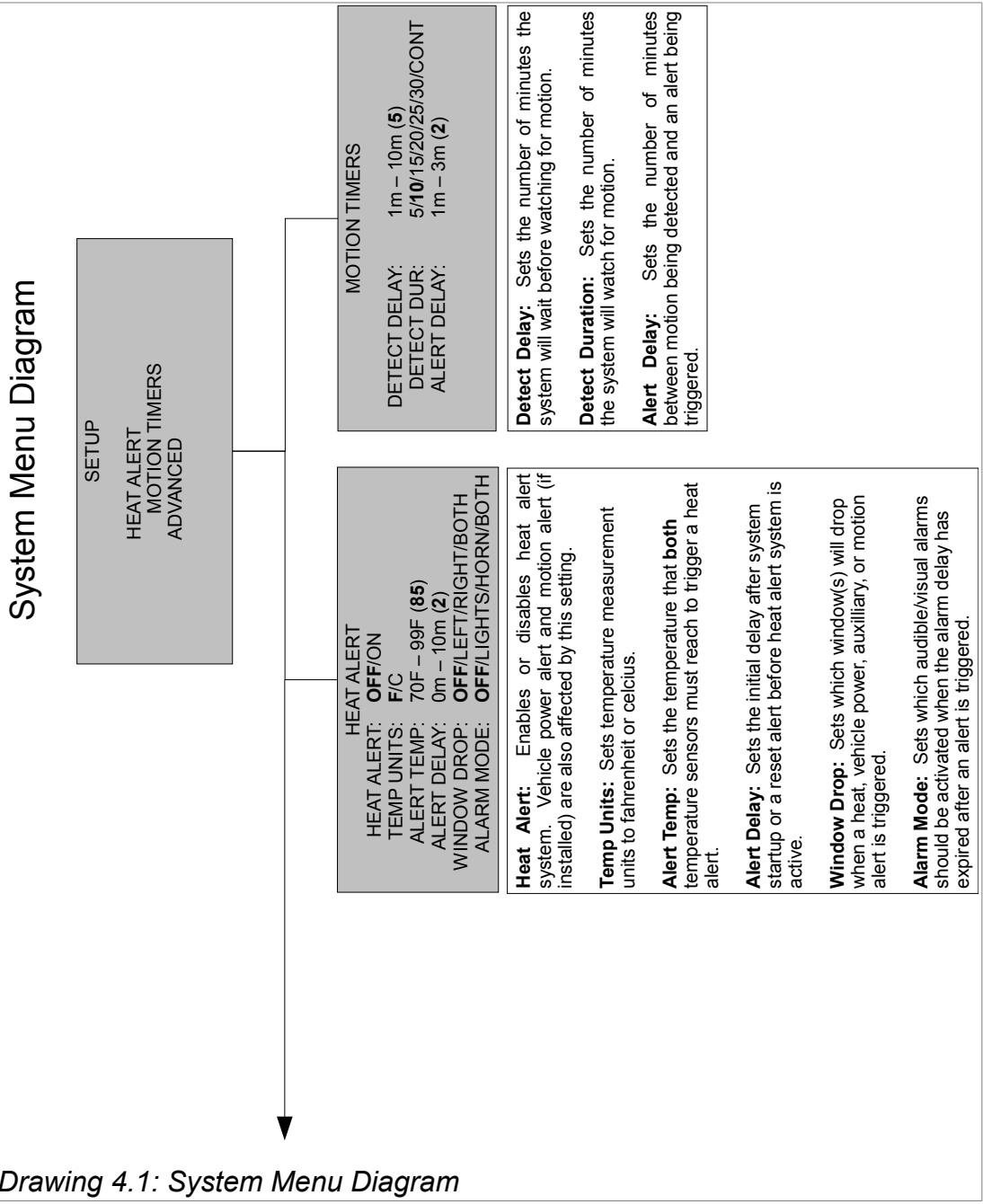

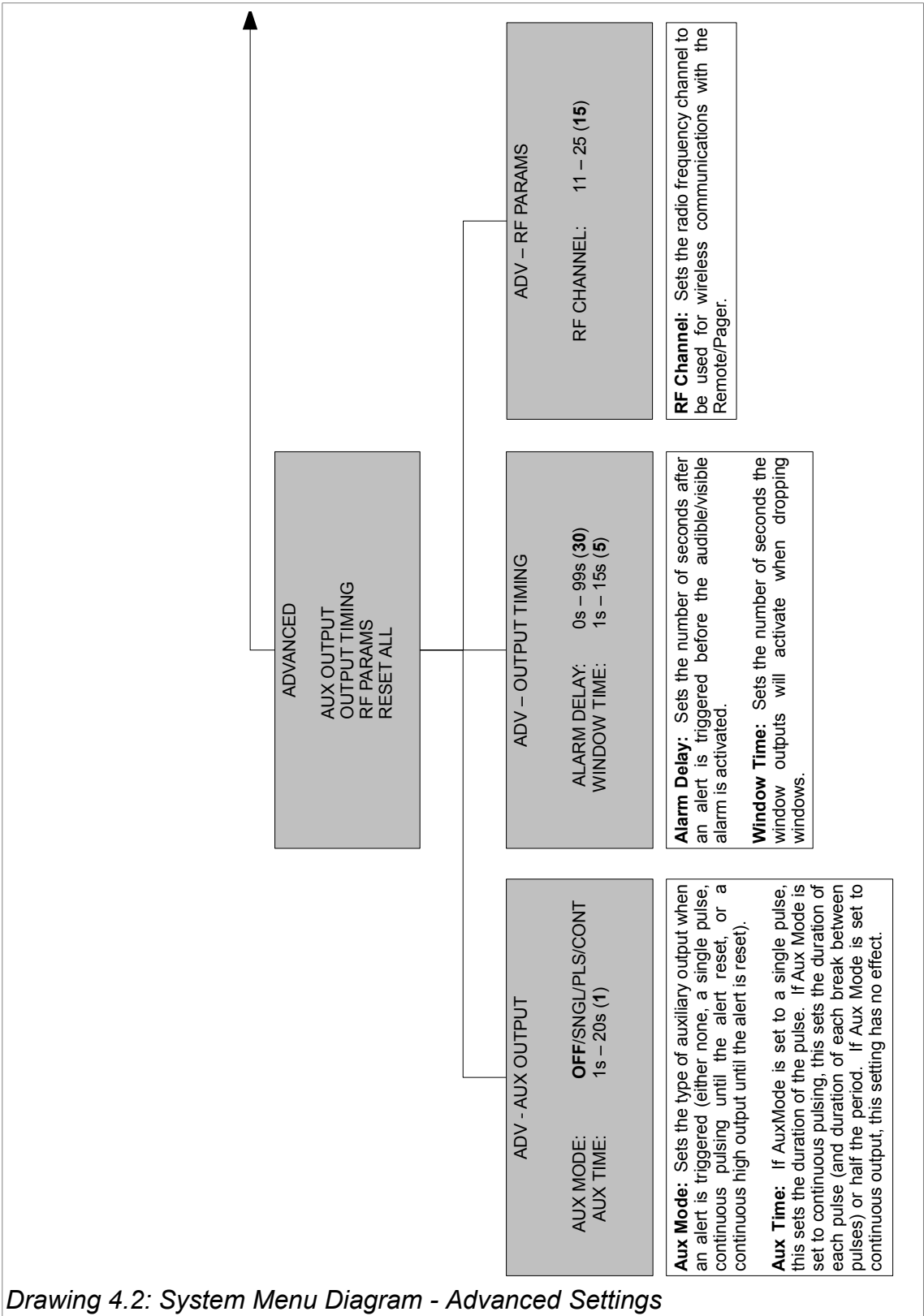

Drawing 4.2: System Menu Diagram - Advanced Settings

5) System Message Descriptions

Displayed Message	Event Description	Remote/Pager Behavior
HIGH TEMP ALERT!	The in-vehicle temperature is at or above the Alert Temp at both sensors.	Continuous, alternating vibrator and beeper (No beeper if 'MUTE' is enabled).
VEHICLE POWER ALERT!	The vehicle battery voltage has dropped below approximately 8 volts.	Continuous, alternating vibrator and beeper (No beeper if 'MUTE' is enabled).
MOTION ALERT!	The motion detector (optional) has detected motion inside the vehicle while the system is powered down	Continuous, alternating vibrator and beeper (No beeper if 'MUTE' is enabled).
AUX INPUT ALERT!	The auxiliary input has received a pulse.	Continuous, alternating vibrator and beeper (No beeper if 'MUTE' is enabled).

Table 5.1: Heat Alert Messages

Displayed Message	Event Description	Remote/Pager Behavior
LOW BATTERY	The Remote/Pager battery needs to be recharged to ensure continued operation.	Periodic vibration and beep (No beeper if 'MUTE' is enabled)
NO SIGNAL XX:XX	The Remote/Pager has not received a signal from the POD for the time specified (approximate)	Vibration and beep after 2 minutes and every 10 minutes after signal is lost (No beeper if 'MUTE' is enabled)

Table 5.2: Remote / Pager Message

6) Product Care and Service

Your system has been designed to give years of trouble free use. Great effort was given to the selection of the highest quality components and fixtures. Following are tips and suggestions that will help keep your system fully functional.

6.1) Heads Up Display

The Heads Up Display (HUD) can be cleaned with a soft, damp cloth. Do not use abrasive cleansers as they can damage the LCD panel and the housing. Your HUD requires no additional user maintenance.

6.2) Remote / Pager

Your Remote/Pager (RP) is designed to be carried on a law enforcement duty belt. Included with your system is a custom belt holster that is engineered to offer durability, ease of use, and comfort when carrying the RP.

Your RP can be cleaned with a soft, damp cloth. Do not use abrasive cleaners as they can damage the LCD panel and the case. Do not submerge the RP in water. However, if the RP does become immersed in water, turn it off immediately. Allow the RP to completely dry before attempting to charge or turn it on again.

7) Troubleshooting

- The Remote/Pager is frozen and won't turn ON/OFF.
 - The RP can be reset by momentarily holding down both of the front buttons at the same time.
- The range of the Remote/Pager is not very good.
 - The wireless connection between the RP and the POD can be changed to a different channel if there are issues with interference. The channel can be changed on the POD by accessing the appropriate menu through the HUD. To change the channel on the RP, hold down the left, front button while the RP is powered down. Skip through the first screen which is used to set the serial number of the POD that the RP is to connect to. The next screen allows you to change the channel number.
- The system turns off when the RP is plugged into the HUD charging cord.
 - When the RP battery is very low, sometimes the initial power demand causes the system to shut down. The system can be powered back up immediately and system operation should continue normally.
- The Remote/Pager does not connect.
 - There is probably a difference of serial number or RF channel between the remote and the main system. Follow these steps to make sure that these two parameters match.
 - Make note of the system serial number displayed on the HUD when it is turned on. It will be labeled "POD SN".
 - Make note of the RF channel located in SETUP → ADVANCED → RF PARAMS.
 - Turn on the RP, and while the Ray Allen logo is being displayed, quickly press and release the MUTE button. The RP will then allow you to adjust the serial number one digit at a time.
 - Adjust each digit to match the serial number displayed by the HUD pressing NEXT to advance to the next digit. After all four digits are set, press NEXT again.
 - Adjust the RF channel to the same value as in the RF PARAMS menu and press NEXT and then DONE on the next screen. The RP will power down. It can now be turned on normally and should connect quickly to the system.

8) Installation

8.1) Read This First!

Installation of this system should be carried out by qualified persons familiar with the general installation of law enforcement electronics commonly installed in police service vehicles. It is recommended that the installer(s) have updated wiring diagrams and schematics of the specific vehicle in which the system will be installed or have access to wiring information through a local dealership or other source.

If you are replacing an existing deployment and/or heat alert system, remove all previous wiring before beginning installation. Our System requires that wiring connections be made as described in this manual - do not connect this to any other system's pre-existing wires.

Any deviation from these instructions that causes damage to any part of the system will void the warranty.

8.2) Before installation

1. Confirm all parts and components are included and accounted for by doing a complete inventory of the package contents.
2. Read this manual to familiarize yourself with the system's unique requirements for installation.
3. Observe all safety practices. It is the installer's responsibility to determine, implement, and observe those safety practices.

Please note:

This system is designed to be directly hardwired to the vehicle's 12-volt battery. Do not connect the system to the vehicle battery until all connections have been completed and verified as being correct.

Do not connect this product to any device intended to detect vehicle battery drain. Doing so may "power down" this product and/or render it ineffective for its intended use.

We recommend that you meet with the intended user to discuss preferences and installation requirements specific to the system's application and user comfort.

8.3) Installation Kit Parts List

Part Description	Kit Qty	Reorder PN	
Antenna	1	F97	
10ft Antenna Cable	1	F77	
Heads-Up Display (HUD)	1	F74	
HUD Articulating Mount w/Hardware Pack (4 screws/nuts)	1	F95	
Remote/Pager Unit	1	F71	
Remote/Pager Holster	2	F91	
120V Remote Charger	1	F99	
In-Vehicle Remote Charging Pigtail	1	F98	



Part Description	Kit Qty	Reorder PN	
System Control POD	1	F73	
Control POD/HUD Communications 15ft Cable (Grey)	1	F94	
Temperature Sensor w/ 15ft cable (Grey w/Black Tip)	2	F85 (Set of 2)	
Electrical Hardware Pack	1	None	
POD & HUD Attachment Hardware Pack (8 self-tapping screws)	1	None	
System Power Wire Harness (15ft)	1	F81	
Vehicle Interface Wire Harness (15ft)	1		

Table 8.3.1: Parts List

8.4) Charge the Remote/Pager

After unpacking the System we recommend that you immediately charge the Remote/Pager. To do this:

1. Locate the Remote/Pager and charger.
2. Plug the charger into a 120v 60hz receptacle (standard wall plug).
3. Plug the charger into the charging port on the side of the Remote/Pager.
4. The message CHARGING BATTERY will appear on the LCD screen of the Remote/Pager.

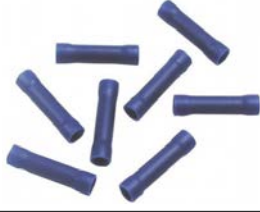
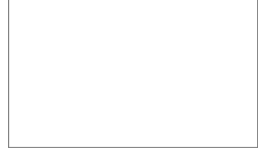
Note: If the Remote/Pager battery is completely dead it may take a few minutes before the charging sequence begins.

Note: We have provided you with a long-life Remote/Pager battery. Depending on temperature, it can take over an hour to fully charge this device. For your convenience, the Remote/Pager is protected by over-charge circuitry therefore it can remain on the charger indefinitely without fear of battery damage.

8.5) Placement of the Control POD

Before starting your installation, consider the most appropriate placement of the system's Control POD in the interior of the vehicle (the POD design requires that it be located inside of the passenger compartment). Be certain that:

1. Both wire harnesses can easily reach the Control POD as well as their intended point of connection to the vehicle components.
2. The antenna connector can be mounted to the roof of the vehicle and still make connection to the Control POD.
3. The Control POD/HUD Communications Cable can be routed from the Heads-Up Display to the Control POD.
4. The Control POD can be securely attached anywhere in the interior of the vehicle (it does NOT need to be grounded). Use the self-tapping screws included to secure the POD to the front panel of your K-9 insert or attach using 2-sided tape, Velcro® or any other attachment method you choose.

All wire harnesses are provided with fifteen (15) feet of wire. The POD/HUD communications cable and antenna cable are ten (10) feet long.

Note: Take care to route all wires away from excessive heat sources and points of possible abrasion.

8.6) Electrical Specifications

Input Voltage	6V - 16V
Supply Current (powered down)	25mA - 30mA
Supply Current (powered up)	100mA - 200mA
Remote / Pager Battery Life*	50h - 80h
Remote / Pager RF Frequency	2.4GHz

Table 8.6.1: Electrical Specifications

* This rating assumes that remote is idling with good, consistent connection with POD.

Control POD/HUD Communications Cable

- A four conductor, unshielded, twisted pair cable terminated on both ends with an RJ9 (4p4c) modular IDC plug

Antenna

- Roof mounted, external
- Omnidirectional
- Part 15 compliant reverse polarity SMA connector
- 10 or 15 foot cable
- NMO high frequency connector

8.7) Wire Harness Details

Pin #	Wire Color	Signal Name	Signal Description
1	Red	System Power Input	Connect directly to positive battery terminal through included 40A fuse.
2	N/A	N/A	N/A
3	Blue	Fan Output	Connect to black fan wire to blow into cage. (This output provides ground for the fan. Do <u>NOT</u> short to positive battery voltage.) Do <u>NOT</u> connect to more than one fan. See 8.12) MD10 F Ray Allen Fan Connection on page 22 for more information.
4	Green	System Power Ground	Connect directly to negative battery terminal.

Table 8.7.1: System Power Wire Harness

Pin #	Wire Color	Signal Name	Signal Description
1	Purple	Left Window Output	Connect to window motor wire that goes from 0 to 12 volts when window is rolled down. See 8.8) Window Lowering Feature Installation on page 20 for more information.
2	N/A	No Connection	N/A
3	N/A	No Connection	N/A
4	Yellow	Horn Output	Connect to vehicle's horn or other auditory alarm device. See 8.11) Lights and Horn Connection on page 22 for more information.
5	Grey	Aux Output	Multifunction auxiliary output.
6	N/A	No Connection	N/A
7	Blue	Right Window Output	Connect to window motor wire that goes from 0 to 12 volts when window is rolled down. See 8.8) Window Lowering Feature Installation on page 20 for more information.
8	Purple / Black	Left Window Pass-Through	Connect to window switch wire that goes from 0 to 12 volts when window is rolled down. See 8.8) Window Lowering Feature Installation on page 20 for more information.
9	Grey / Black	Aux Input	Connect to any peripheral device that sends a 12 volt pulse when alert is desired.
10	Red / Black	Aux Power	Connect to any peripheral device that needs to be powered when system is turned on.
11	N/A	No Connection	N/A
12	White	Lights Output	Connect to vehicle's parking lights or any other visual alarm device. See 8.11) Lights and Horn Connection on page 22 for more information.
13	N/A	No Connection	N/A
14	Blue / Black	Right Window Pass-Through	Connect to window switch wire that goes from 0 to 12 volts when window is rolled down. See 8.8) Window Lowering Feature Installation on page 20 for more information.

Table 8.7.2: Vehicle Interface Wire Harness

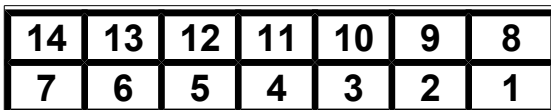

Drawing 8.7.1: Connector Numbering Diagram (viewed from wire side)

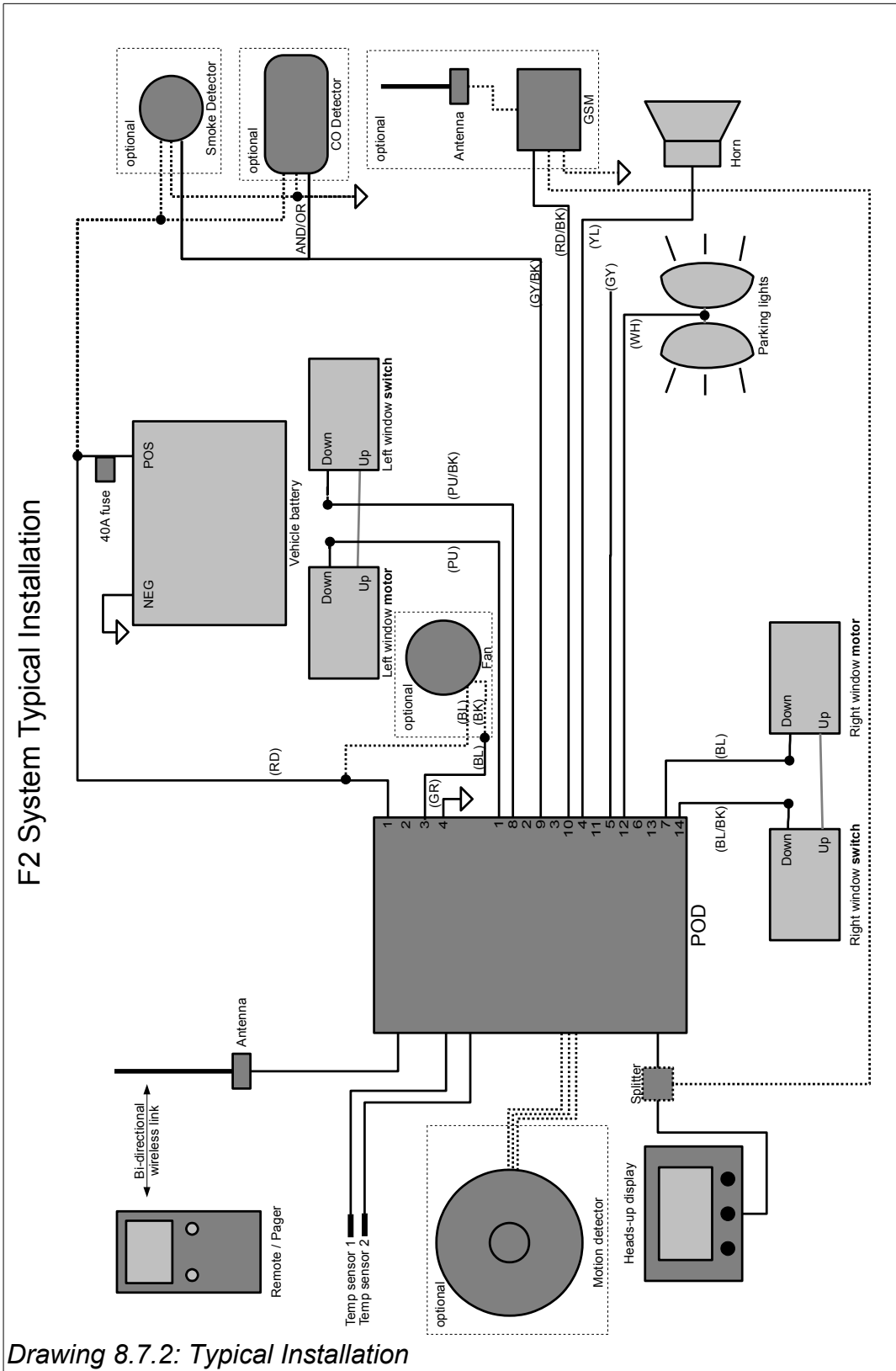

8.8) Window Lowering Feature Installation

The vehicle interface wiring harness included with this system has 2 wires designated for this feature for each rear side window. These wires should be routed from the 'B' pillar through the conduit into each door. Make the connection inside each door.

To determine the wire in the door to splice into, activate the window switch and, using a volt-meter, determine which of the two wires connecting the control switch to the window motor changes from 0 to 12 volts during the lowering of the window ("down wire"). Cut this wire and connect the window output wire (identified from the vehicle interface harness table) to the motor side of this wire. Connect the window pass-through wire to the switch side of this wire. Butt-splices are included for these connections. Ensure these wires are connected correctly as switching them will cause a dead short that could cause damage to the system.

The window activation duration should be adjusted through the Advanced Menu to a setting that is just long enough the drop each window completely. See 4) System Menu on page 7 for more information on adjusting this setting.

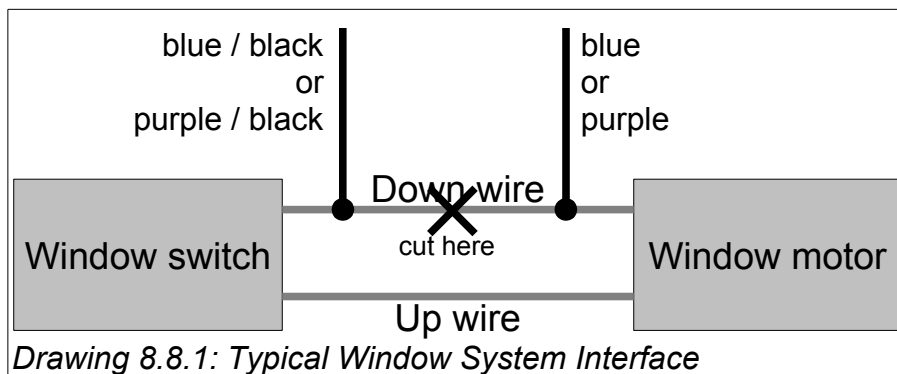

8.9) Antenna Attachment

The provided antenna cable assembly is 10 feet in length. The cable should be run from the POD to a 3/4" hole drilled through the roof of the vehicle. The antenna connector is a modified NMO style terminal. The center contact and plastic washer must be removed in order to attach the antenna.

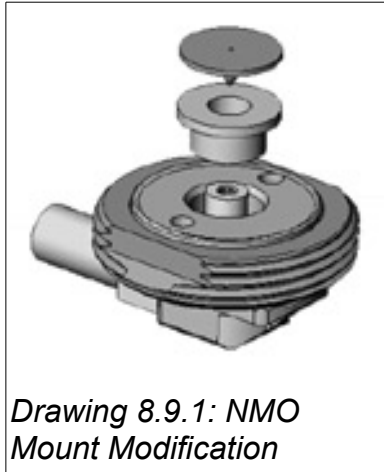

8.10) Temperature Sensor Placement

You have been provided with two (2) Temperature Sensors which are specifically designed to work with this system. Each Sensor has fifteen (15) feet of cable. These Sensors are plugged into the system Control POD (the two plugs next to the antenna port – opposite side of the wiring harnesses). Care should be taken before deciding where their final mounting point should be. We have provided hook and loop fasteners (Velcro®) to secure these Sensors. Place the cable under the Velcro® so that the black Temperature Sensor is completely exposed.

Consider:

- Neither Sensor should be mounted in a position that is subject to direct sunlight nor in close proximity to air conditioning vents or the roof of the vehicle -- Doing so will give incorrect readings of the “true” temperature inside the vehicle.
- Cables should be routed to avoid points of possible abrasion.
- Be certain the K9 cannot get to the sensors. They are **not** chew proof.

8.11) Lights and Horn Connection

Under the dashboard, at the fuse panel or under the hood of the vehicle, locate the wires used for these features. Activate the lights and the horn from inside of the vehicle. Using a volt-meter, determine the wire that changes from 0 to 12 volts when these features are activated. Carefully splice into this circuit. On certain vehicles it may be necessary to splice into the wiring circuit beyond relays and fuse boxes.

8.12) MD10 F Ray Allen Fan Connection

The Ray Allen MD10 F Fan is designed to bolt directly to either side of the front panel on the Ray Allen Cruise Eze™. Hardware for this installation is included with the Fan. When attaching the Fan to the front panel of your Cruise Eze™, we suggest you insert the bolts and washers from inside of the cage and place the nut on the Fan side. You do not want the nut on the inside of the cage as it has a higher profile than the bolt head and this may injure the dog.

Also included is the wiring to connect directly to the system’s Control POD. To complete this connection, attach the fan output wire from the POD to the black wire on the fan (butt-splices are included for this connection). Connect the blue wire from the fan to a positive battery voltage. The POD is designed to control only one fan. Therefore, do not connect the POD's fan wire to multiple fans. Test this connection when testing the complete system. This fan is designed to blow “in” to the Cruise Eze™ unit. If for some reason you wish this fan to blow in the opposite direction, simply reverse these wire connections.

8.13) Placement of Heads Up Display (HUD)

The HUD is the system's user interface used for information read-outs and feature programming therefore easy access to the HUD visually and physically is vital. We have included an articulating mount that can be used for this purpose. This mount easily attaches to the HUD using the self-tapping screws included in your hardware pack. Once the location has been determined (we recommend the intended user be involved in this decision) the base of the mount can be permanently attached to the vehicle utilizing the two-sided tape already on the base. This tape is extremely adhesive so you will only get one shot at this.

If you wish to mount the HUD directly to the dashboard as shown below (photo on the right), either attach the HUD using the self-tapping screws or attach with Velcro® or two-sided tape.

Note: Take care to route the communication cable away from excessive heat sources or points of possible abrasion.

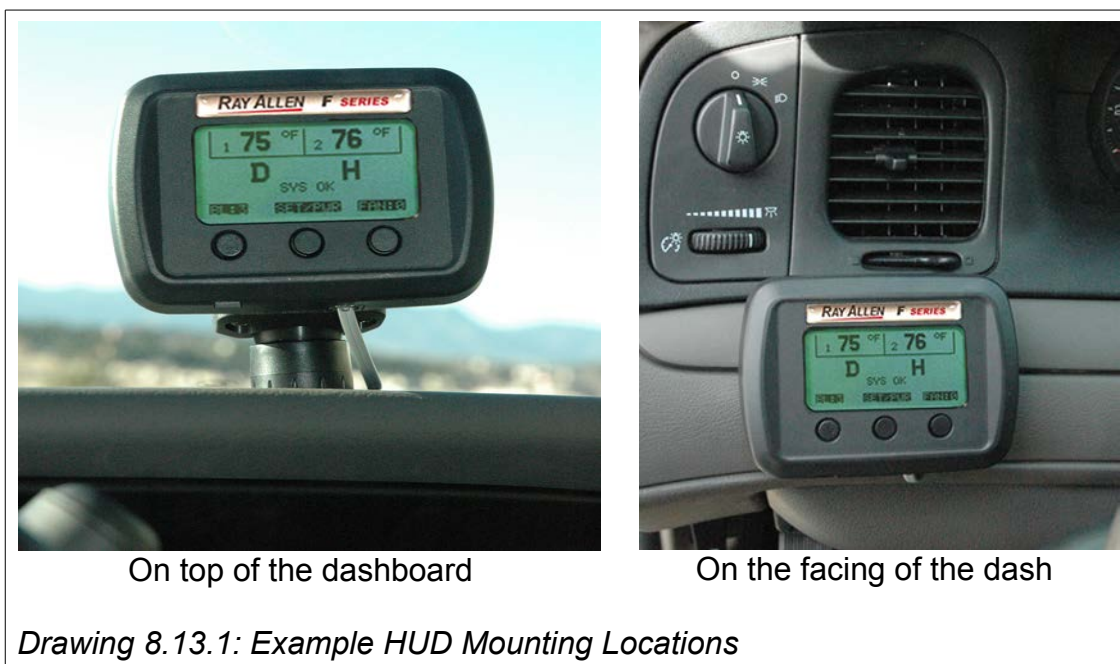

8.14) Completing the Installation

Verify the following before proceeding:

- All connections except the four-conductor, black system power connector are securely attached to the Control POD.
- The other end of the gray data cable is connected to the HUD.
- All wire splices and butt connectors are secure and that there is no chance of a short circuit.

Once all of the above is completed, connect the System's Power and Ground cables to the vehicle battery's positive and negative terminals and plug the four-conductor, black system power connector into the POD.

Power up the system by pressing and holding down the center button on the front of the HUD. When the display appears, release the button. The HUD will run a self diagnostic routine. Upon completion of this routine proceed to the following steps.

8.15) Testing the HEAT ALERT™ System

For this test it is important that all vehicle windows are closed.

Start the vehicle and power up the HUD and the Remote/Pager. Be sure that the fan is off through the HUD.

In the SETUP Menu, select HEAT ALERT, then set the system values as follows (refer to the Users Manual if necessary):

HEAT ALERT	“ON”
TEMP MODE	“F”
ALERT TEMP	“70”
ALERT DELAY	“01”
WINDOW DROP	“BOTH”
ALARM MODE	“BOTH”

Exit the SETUP Menu. On the HUD display, insure that the H on the LCD is now bold without a circle w/line over it (if it is not bold, wait one minute for the “alert delay” to time-out).

If necessary, turn on the vehicle heater and adjust to high to raise the interior temperature of the vehicle. When the interior of the vehicle reaches 70F and BOTH sensors indicate 70F or above.

Heat Alert Test Sequence:

1. The HUD and the Remote/Pager will display HIGH TEMP ALERT.
2. The windows that have been wired into the system will lower.
3. After the windows have lowered, the system will turn on the fan at full speed (if the optional fan is installed).

Approximately 30 seconds after a HEAT ALERT™ has activated and not been reset, the vehicle’s horn (if integrated) will sound and the lights (if integrated) will flash. If both the horn and lights are connected and selected in the ALERT MODES menu, they will alternate.

The HEAT ALERT™ can be reset by pressing the RESET button once on the Remote/Pager or the HUD. The fan will continue to run at high speed and the windows will remain down but the heat alert will delay for one (1) minute (the amount of time set as the ALERT DELAY).

Note: When this test is completed successfully, we suggest that you reset the ALERT TEMP to 85F.

8.16) Confirming Normal Operation

Once the system is fully tested and operational, the HUD display will look similar to the photo below (with the actual temperature readings from your vehicle).

Verify the following on the HUD:

- It shows two temperatures.....
- A bold "H" appears as shown.....
- System Status is "SYS OK".....
- Pressing left button adjusts back-light.....
- Pressing right button adjusts fan speed.....

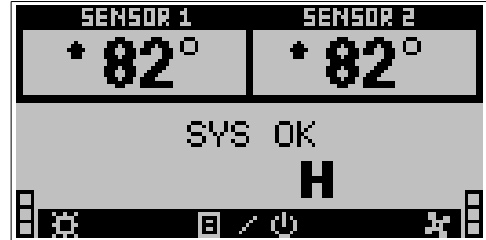

Drawing 8.16.1: Functional HUD Display

Verify the Following on the Remote / Pager:

- It connects to the system.....
- It shows two temperatures.....
- A bold "H" appears as shown.....
- System Status is "SYS OK".....
- Signal Strength is maximum.....
- Battery Level is maximum.....

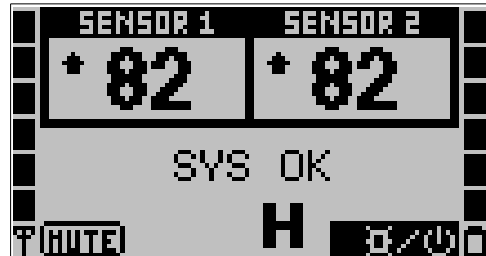

Drawing 8.16.2: Functional Remote / Pager Display

If the Remote/Pager will not connect to the system, see the troubleshooting section of the User's Manual.

9) Warranty

Two Year Warranty

Ray Allen Manufacturing, LLC guarantees the purchaser that this F Series System will perform without defect in materials and workmanship for a period of two years from date of purchase. Ray Allen Mfg. will replace or repair defective materials at its discretion.

Exclusions to this warranty include, but are not limited to, acts of God or nature, vehicle accidents, product misuse or alteration (without the explicit direction of Ray Allen) or improper installation. Warranty does not include cost of removal, installation, labor, or any other cost incurred by purchaser. Ray Allen Manufacturing, LLC assumes no responsibility or liability for installation, use or misuse of the F Series System.

This warranty is valid for the original installation of this unit and is voided if the F Series System is removed from the originally installed vehicle and installed into another vehicle.

Warranty service requests are to be reported by phone to Ray Allen at (800) 444-0404 or sent in writing via e-mail to Fseries@rayallen.com. Requests require the serial # of the System and original sales order number to be processed.

To activate your warranty, register your product on the Ray Allen website. Go to the following link to process your registration:

www.rayallen.com/fseries/register

10) Disclaimer

Ray Allen Manufacturing, LLC can, at its discretion and without prejudice, make improvements to these products at any time. These improvements may or may not be made available to previously purchased products.

This product is designed for sale and use within the United States of America and its territories. Ray Allen Manufacturing, LLC will assume no liability or responsibility for any use or installation of this system outside of the USA. Such use is the sole responsibility of the purchaser.

This equipment has been tested and found to comply with the limits for a Class B digital device, pursuant to part 15 of the FCC Rules. These limits are designed to provide reasonable protection against harmful interference in a residential installation. This equipment generates, uses and can radiate radio frequency energy and, if not installed and used in accordance with the instructions, may cause harmful interference to radio communications. However, there is no guarantee that Interference will not occur in a particular installation, If this equipment does cause harmful Interference to radio or television reception, which can be determined by turning the equipment off and on, the user is encouraged to try to correct the interference by one or more of the following measures:

- Reorient or relocate the receiving antenna
- Increase the separation between the equipment and receiver
- Connect the equipment into an outlet on a circuit different from that to which the receiver is connected
- Consult an experienced technician for help

This device complies with part 15 of the FCC Rules. Operation is subject to the following two conditions: (1) This device may not cause harmful interference, and (2) this device must accept any interference received including interference that may cause undesired operation.

Caution: changes or modifications not expressly approved by Ray Allen Manufacturing, LLC could void the user's authority to operate the equipment.